

# INVERTER MCE/C

MCE/C 11-MCE/C 15-MCE/C 22

MCE/C 30-MCE/C 55

MCE/C 110-MCE/C 150





## Description

The new MCE/C inverters are the latest technological challenge in the DAB inverters universe. They constitute the new generation of inverters for use with circulator pumps and stand out for ease of use, power, and simplicity of installation and management.

MCE /C inverters are designed for use with circulator pumps to enable simple control of differential pressure, thereby adapting pump performance to match effective system requirements.

The solution of mounting on the motor base greatly simplifies installation of the pump with MCE/C in minimal times. The inverters feature IP55 protection rating. Ease of programming is guaranteed by the use of an interface similar to DAB Dialogue and a graphic display.

MCE/C inverters feature dual microprocessor architecture to guarantee maximum efficiency and reliability. Sturdy and reliable construction is combined with modern and innovative styling to complete the product also in terms of aesthetics. MCE/C inverters protect the pump thanks to integrated safety devices. They are also able to prolong the useful lifetime of the pump thanks to the elimination of water hammer and rotation of the pump at the minimum rpm necessary to meet the requirements of the user. Last but not least, these inverters save power by keeping pump consumption to the minimum levels strictly necessary to meet user requirements.

Equipped with communication module for the creation of twin pumpsets

## Benefits

### Why the Dab inverter?

The MCE/P units are air cooled. These extremely robust panel-mounting inverters feature a metal body and are suitable for heavy-duty applications. To enable operation these need a differential pressure sensor MCE/C. MCE/P combines practicality with easy installation and management. MCE/P ensure the utmost practicality and increase the average working life of the system, permitting also significant savings in power consumption.

### Advantages

- Easily installed in existing systems
- Constant pressure
- Power consumption reduced by up to 60%
- Built-in protections
- Operates with all pumps
- Robust
- Facility to create sets with interchange of up to 8 pumps
- IP55 protection rating



## Characteristics

### MCE/C 11 – MCE/C 15 – MCE/C 22

- Self-ventilated panel-mounting inverters for hydraulic pumps.
- Per pompe trifase fino a 3HP - 2,2kW
- OLED graphic display
- Input power supply 1 x 230V 50-60Hz
- Pump voltage 3 x 230V
- Electric pump nominal frequency 50-200 Hz
- Control range in accordance with the sensor utilised, with standard range of 1-24bar
- Protections against voltage surges
- Adjustable overload protection
- Extended connectivity
- Protection rating: IP55
- Short circuit between output phases
- Overtemperature protection
- Possibility of creating intercommunicating twin pumpsets

### MCE/C 30 – MCE/C 55

- Self-ventilated panel-mounting inverters for hydraulic pumps.
- For three-phase pumps up to 7.5 HP - 5.5 kW
- OLED graphic display
- Input power supply 3 x 400V 50-60Hz
- Pump voltage 3 x 400V
- Electric pump nominal frequency 50-200 Hz
- Control range in accordance with the sensor utilised, with standard range of 1-24bar
- Protections against voltage surges
- Adjustable overload protection
- Extended connectivity
- Protection rating: IP55
- Short circuit between output phases
- Overtemperature protection
- Possibility of creating intercommunicating twin pumpsets

### MCE/C 110 – MCE/C 150

- Self-ventilated panel-mounting inverters for hydraulic pumps.
- For three-phase pumps up to 20HP – 15kW
- OLED graphic display
- Input power supply 3 x 400V 50-60Hz
- Pump voltage 3 x 400V
- Electric pump nominal frequency 50-200 Hz
- Control range in accordance with the sensor utilised, with standard range of 1-24bar
- Protections against voltage surges
- Adjustable overload protection
- Extended connectivity
- Protection rating: IP55
- Short circuit between output phases
- Overtemperature protection
- Possibility of creating intercommunicating twin pumpsets

Model	Max. motor current A	Max. motor power kW	Power supply V	Pump Input V	Parallel user interface	Maximum dimensions L x H x P
<b>MCE/C 11</b>	6.5	1.1	Mono-phase 1x230	Three-phase 3x230	SI	205 x 205 x 265
<b>MCE/C 15</b>	8,0	1.5	Mono-phase 1x230	Three-phase 3x230	SI	205 x 205 x 265
<b>MCE/C 22</b>	10.5	2.2	Mono-phase 1x230	Three-phase 3x230	SI	205 x 205 x 265

		MCE/C 11	MCE/C 15	MCE/C 22
Inverter power feeding	Voltage [VAC] (Tolerance +10/-20%)	220-240		
	Phases	1		
	Frequency [Hz]	50 - 60 Hz		
	Current [A]	12	18,7	22
Inverter power output	Voltage [VAC] (Tolerance +10/-20%)	0 - V power supply		
	Phases	3		
	Frequency [Hz]	0-200		
	Current [A]	6,5	8	10.5
	Max electrical power output [kVA] (400 Vrms)	1,5	2	2.8
	Mechanical power rating P2	1,5 CV / 1,1 kW	2 CV / 1,5 Kw	3 CV / 2,2 kW
Mechanical characteristics	Unit weight [kg] (packing included)	5.0		
	Maximum dimensions [mm] (WxHxD)	205 x 205 x 265		
Installation	Operating position	Any position		
	IP protection rating	55		
	Maximum ambient temperature [°C]	40		
	Maximum conductor section accepted by input and output terminals [mm <sup>2</sup> ]	4		
	Minimum cable diameter accepted by inlet and outlet cable glands [mm]	6		
	Maximum cable diameter accepted by inlet and outlet cable glands [mm]	12		
Control and operation hydraulic characteristics	Pressure control range [bar]	1 – 95% pressure sensor full scale		

		MCE/C 11	MCE/C 15	MCE/C 22
Sensors	Types of pressure sensor	Ratiometric sensor		
	Full scale of differential pressure sensors [bar]	4 / 10		
Functions and protections	Connectivity	Serial interface - Remote control - Multi inverter connection		
	Protections	Self-protected against current surges Internal electronics overtemperature Power supply voltage anomalies Direct shorting between output phases		

# TECHNICAL DATA

## MCE/C 30 – MCE/C 55



Model	Max. motor current A	Max. motor power kW	Power supply V	Pump Input V	Parallel user interface	Maximum dimensions L x H x P
<b>MCE/C 30</b>	7,5	3	Three-phase 3x400	Three-phase 3x400	SI	270 x 355 x 195
<b>MCE/C 55</b>	13,5	5,5	Three-phase 3x400	Three-phase 3x400	SI	270 x 355 x 195

		MCE/C 30	MCE/C 55
Inverter power feeding	Voltage [VAC] (Tolerance +10/-20%)	380-480	
	Phases	3	
	Frequency [Hz]	50 - 60 Hz	
	Current [A]	11,5 - 9,0	17,0 - 13,0
Inverter power output	Voltage [VAC] (Tolerance +10/-20%)	0 - V power supply	
	Phases	3	
	Frequency [Hz]	0-200	
	Current [A]	7,5	13,5
	Max electrical power output [kVA] (400 Vrms)	4,0	7,0
Mechanical power rating P2	4 CV/3.0 Kw	7,5 CV / 5,5 kW	
Mechanical characteristics	Unit weight [kg] (packing included)	7,6	
	Maximum dimensions [mm] (WxHxD)	270 x 355 x 195	
Installation	Operating position	Any position	
	IP protection rating	55	
	Maximum ambient temperature [°C]	40	
	Maximum conductor section accepted by input and output terminals [mm <sup>2</sup> ]	6	
	Minimum cable diameter accepted by inlet and outlet cable glands [mm]	11	
Maximum cable diameter accepted by inlet and outlet cable glands [mm]	17		
Control and operation hydraulic characteristics	Pressure control range [bar]	1 – 95% pressure sensor full scale	

		MCE/C 30	MCE/C 55
Sensors	Types of pressure sensor	Ratiometric sensor	
	Full scale of differential pressure sensors [bar]	4 / 10	
Functions and protections	Connectivity	Serial interface - Remote control - Multi inverter connection	
	Protections	Self-protected against current surges Internal electronics overtemperature Anomalous power supply voltage Direct shorting between output phases	

Model	Max. motor current A	Max. motor power kW	Power supply V	Pump Input V	Parallel user interface	Maximum dimensions L x H x P
<b>MPE/C 110</b>	24	11,0	Three-phase 3x400	Three-phase 3x400	SI	340 x 430 x 250
<b>MPE/C 150</b>	32	15,0	Three-phase 3x400	Three-phase 3x400	SI	340 x 430 x 250

		MPE/C 110	MPE/C 150
Inverter power feeding	Voltage [VAC] (Tolerance +10/-20%)	380-480	
	Phases	3	
	Frequency [Hz]	50 - 60 Hz	
	Current [A]	32,5-26,0	42,0-33,5
Inverter power output	Voltage [VAC] (Tolerance +10/-20%)	0 - V power supply	
	Phases	3	
	Frequency [Hz]	0-200	
	Current [A]	24,0	32,0
	Max electrical power output [kVA] (400 Vrms)	14,0	19,0
	Mechanical power rating P2	15 CV / 11 kW	20 CV / 15 kW
Mechanical characteristics	Unit weight [kg] (packing included)	12,0	
	Maximum dimensions [mm] (WxHxD)	340 x 430 x 250	
Installation	Operating position	Any position	
	IP protection rating	55	
	Maximum ambient temperature [°C]	40	
	Maximum conductor section accepted by input and output terminals [mm <sup>2</sup> ]	4	
	Minimum cable diameter accepted by inlet and outlet cable glands [mm]	16	
	Maximum cable diameter accepted by inlet and outlet cable glands [mm]	17	
Control and operation hydraulic characteristics	Pressure control range [bar]	1 – 95% pressure sensor full scale	

		MPE/C 110	MPE/C 150
Sensors	Types of pressure sensor	Ratiometric sensor	
	Full scale of differential pressure sensors [bar]	4 / 10	
Functions and protections	Connectivity	Serial interface - Remote control - Multi inverter connection	
	Protections	Self-protected against current surges Internal electronics overtemperature Anomalous power supply voltage Direct shorting between output phases	

Reducing motor speed, even marginally, can lead to an appreciable reduction in power consumption because the absorbed power of an electric motor is proportional to the rpm cubed. For example, a pump powered by the mains that runs at approximately 2950 rpm, will run approximately 20% slower (i.e. at 2360 rpm) when fed with a 40 Hz supply, leading to a saving of 40% in terms of absorbed power.

The motor speed reduction increases pump life significantly, thanks to the reduction of mechanical stress.

**Pump performance in relation to variations in rpm**

Pump rpm  $n$  has a very significant influence on pump performance. In the absence of cavitation phenomena the law of similarity is applicable, as shown in equation 1.

- Flow rate changes in a linear manner with changes in speed.
- Pressure changes in a squared relationship with changes in rpm.
- Power changes in a cubed relationship with changes in rpm.
- A small change in rpm produces a very large change in power.

Equation 1

$$\frac{Q_x}{Q} = \frac{n_x}{n} \quad Q = Q_x \frac{n_x}{n}$$

$$\frac{H_x}{H} = \left(\frac{n_x}{n}\right)^2 \quad H_x = H \left(\frac{n_x}{n}\right)^2$$

$$\frac{P_x}{P} = \left(\frac{n_x}{n}\right)^3 \quad P_x = P \left(\frac{n_x}{n}\right)^3$$

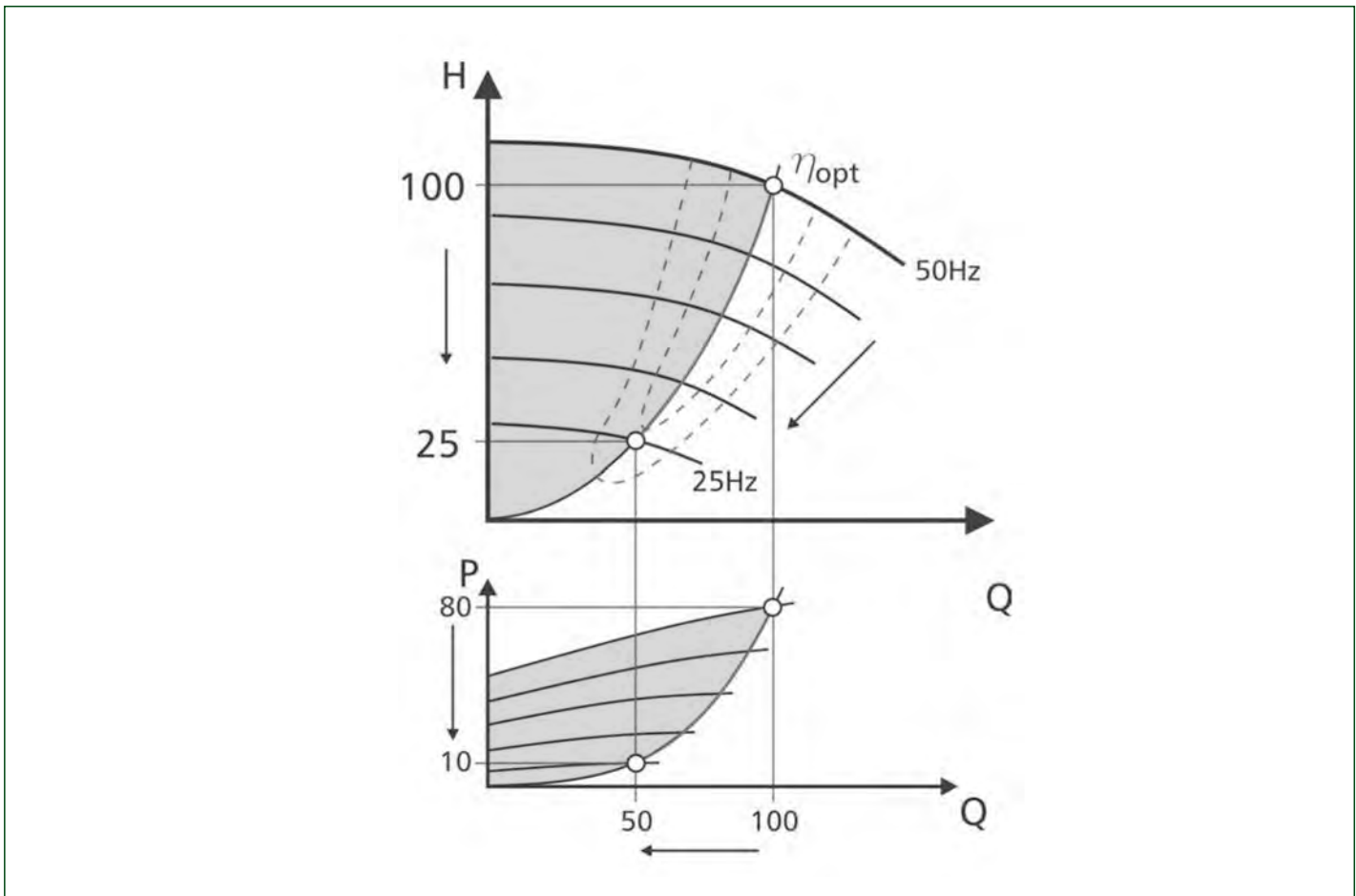

- a lowering of the flow acc. to the linear function
- a reduction of the head according to a quadratic function
- a reduction of the power consumption acc. to a cubic function!

The new MCE/C inverters are the latest milestone in DAB inverter design. They are the new generation of inverters for use with circulation pumps and offer outstanding user-friendliness, power and ease of installation and use. MCE/C inverters are designed to control circulation pumps and allow the pump's output to be adapted to the system's actual requirements through simple control of the differential pressure. They are mounted on the motor fan casing. This makes installation of pumps with MCE/C particularly quick and easy. The MCE/C device has IP55 protection. Trouble-free programming is ensured by the use of a simple, intuitive interface similar to that on Dialogue electronic circulators and a graphic display. MCE/C inverters are built with two microprocessors, guaranteeing unbeatable efficiency and reliability.

Reliable and rugged construction plus modern and innovative styling complete the product also from an aesthetic standpoint. MCE/C inverters protect the motor and the pump and extend their lifetime because they prevent hammer blows and operate the pump at the minimum rpm required to meet the user's demands. What's more, electric pumps controlled by the MCE/C inverter are environment-friendly, since by ensuring that the pump only consumes the power strictly necessary to meet the user's demands they cut electricity consumption significantly compared to fixed speed units. Possibility of creating twin units using the special MCE/C inverter connection cable.

## OPERATING MODES

All the functions listed below can be consulted by all users (even the least skilled) by just scrolling through the MCE/C menu. Calibration and parameter modification are protected functions, permitted only to skilled users.

### Constant differential pressure control mode $\Delta P-c$

$\Delta P-c$  control mode keeps the system's differential pressure constant at the  $H$  value set (setp) as the flow rate varies. This is the standard control mode, for normal use. It can be set directly from the MCE/C's control panel. The inverter maintains the differential pressure ( $H$  setp) constant as the flow rate varies.

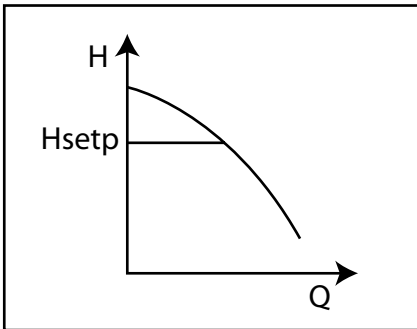

**This control mode is particularly useful in the following types of installations:**

- A** Two-pipe central heating systems with thermostatic valves
- B** Under-floor central heating systems with thermostatic valves
- C** Single-pipe central heating systems with thermostatic and calibration valves
- D** Installations having primary circuit pumps

### Constant curve control mode

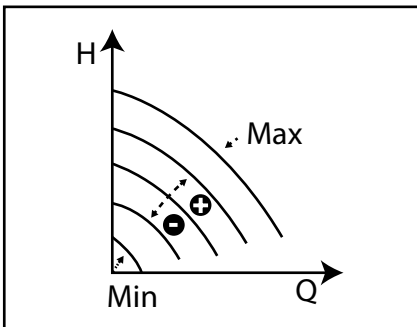

### Constant curve control

The rotation speed is kept at a constant rpm. The rotation speed can be set between a minimum value and the rated frequency of the circulation pump (e.g. between 15 Hz and 50 Hz). This mode can be set using the control panel on the cover of the MCE.

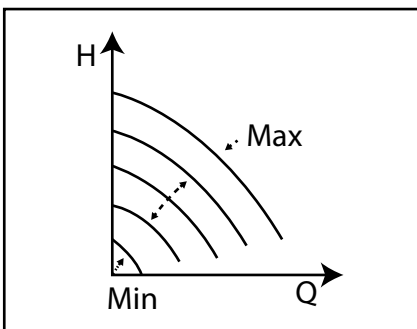

### Constant Curve Control with Remote Analogue Signal

The rotation speed is kept at a constant number of rpm proportional to the voltage of the remote analogue signal. The rotation speed varies on a linear scale between the rated frequency of the pump when  $V_{in} = 10V$  and the minimum frequency when  $V_{in} = 0V$ . This mode can be set using the control panel on the cover of the MCE.



## 1 Hydraulic diagram

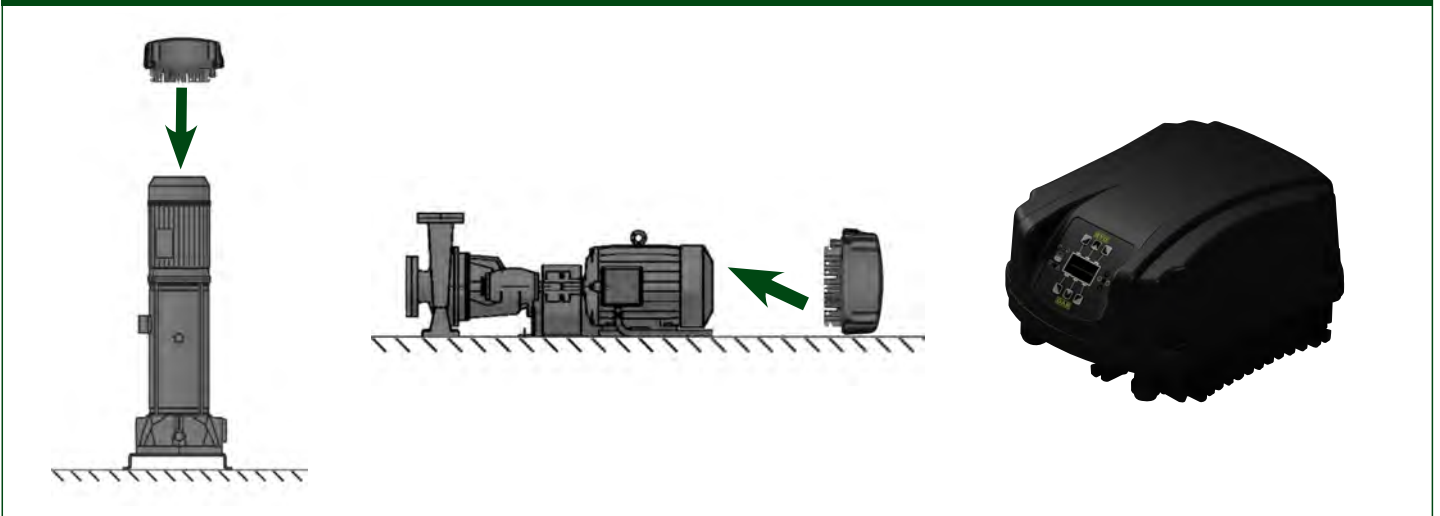

The MCE is installed on the motor base. The inverter can operate both vertically and horizontally. 2 kits are available for assembly on the motor:

### Tie-rods:

These are connected to the MCE dissipator and fan cover. They require a solid fan cover able to withstand the weight of the inverter, i.e. secured by means of bolts or screws.

### Fan cover kit:

The fan cover kit is used in all situations where the fan cover is not sufficiently solid or strong enough to withstand the weight of the inverter.

## TWIN OPERATION

Groups of up to 2 pumps can be created. To do this, the pumps must be hydraulically connected to the same output and inlet manifolds (naturally, this is not necessary for twin circulation pumps).

The 2 MCE/C inverters also have to be connected using the special interconnection cable, connecting both inverters to one of the 2 connectors marked Link. For the twin system to operate correctly, all the external connections of the input terminal board must be parallel connected between the 2 MCE/C units, with the numbers of the individual pins corresponding (e.g. pin 17 of MCE-22/C-1 to pin 17 of MCE-22/C-2 and so on).

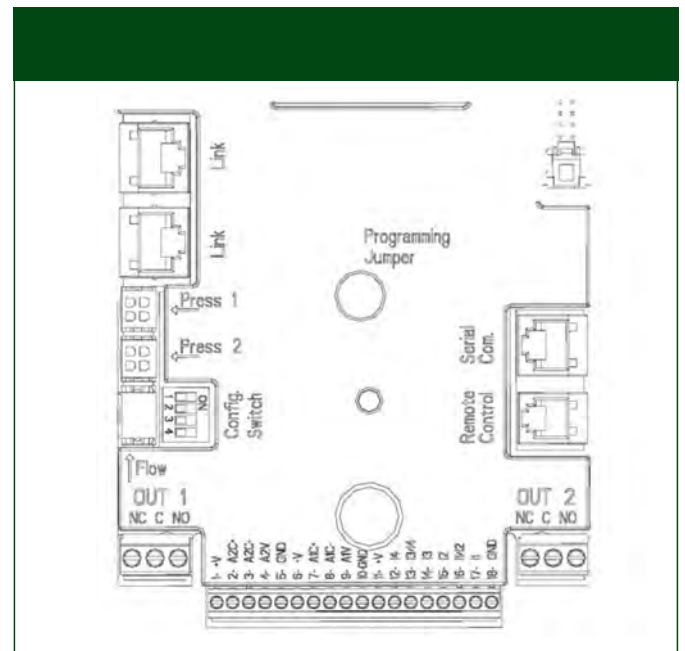

## Connection of the power line

### Single-phase electric connection diagram (up to MCE-22/C)

The connection between the MCE-22/C and the single-phase power supply line must be made with a 3-wire cable (live + neutral + ground). The input terminals are marked LINE LN with an arrow pointing into the terminals. (see Figure 1)

The input and output cables must be large enough to allow the cable clamps to grip them effectively, while the maximum permitted gauge on the terminals is 4 mm<sup>2</sup>. The electric pump supply current is generally specified on the motor dataplate. Generally, the maximum power supply current of the MCE-22/C can be estimated as twice the maximum current absorption of the pump. Although the MCE-22/C has its own internal protection devices, an overload cutout of suitable rating should also be installed.

### Three-phase connection diagram (MCE-30/C and MCE-55/C)

The connection between the MCE-30/C and MCE-55/C and the three-phase power supply line must be made with a 4-wire cable (3 phases + ground). The input terminals are marked LINE RST with an arrow pointing into the terminals. (see Figure 2)

The maximum permitted wire gauge of the input and output terminals is 6 mm<sup>2</sup>. The input and output cable outside diameter which will allow the cable clamps to secure them correctly varies from a minimum of 11 mm<sup>2</sup> up to a maximum of 17 mm<sup>2</sup>. The electric pump supply current is generally specified on the motor dataplate. Generally, the power supply current of the MCE-55/C can be estimated as 1/8 greater than the maximum current absorption of the pump (with a safety margin). Although the MCE-55/C has its own internal protection devices, an overload cutout of suitable rating should also be installed.

### Three-phase connection diagram (MCE-110/C and MCE 150/C)

The connection between the MCE-110/C and MCE-150/C and the three-phase power supply line must be made with a 4-wire cable (3 phases + ground). The input terminals are marked LINE RST with an arrow pointing into the terminals. (see Figure 3)

The input and output cables must have gauge of at least 6 mm<sup>2</sup> to allow the cable clamps to grip them effectively, while the maximum permitted gauge on the terminals is 16 mm<sup>2</sup>.

Generally, the power supply current of the MCE-110/C and MCE-150/C can be estimated as 1/8 greater than the maximum current absorption of the pump (with a safety margin). Although the MCE-110/C and MCE-150/C have their own internal protection devices, an overload cutout of suitable rating should also be installed.

MCE/C 11 – MCE/C 15 – MCE/C 22

figure 1



MCE/C 30 - MCE/C 30

figure 2

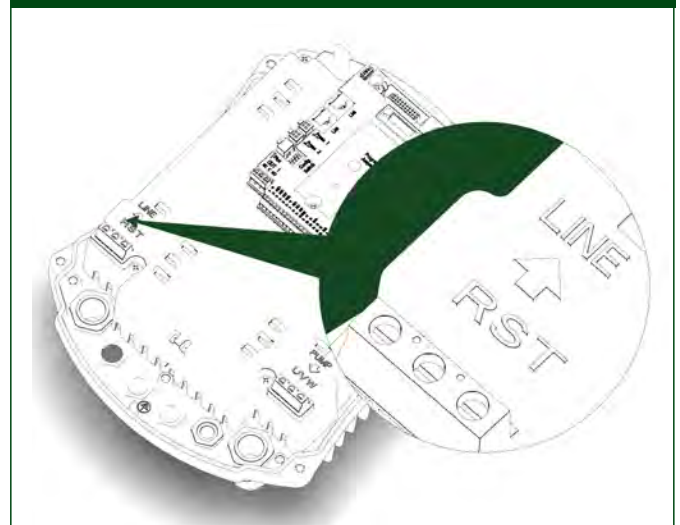

MCE/C 110 - MCE/C 150

figure 3

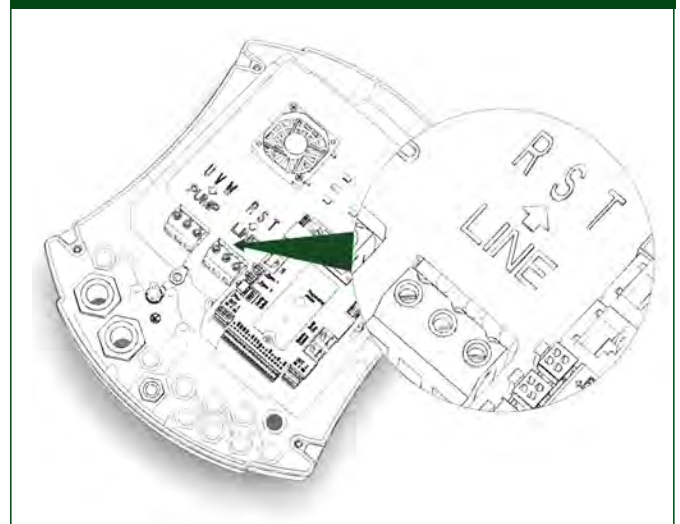

# QUICK START GUIDE

## PUMP AND POWER SUPPLY CONNECTION

### MCE/P 11 – MCE/P 15 – MCE/P 22

Installation

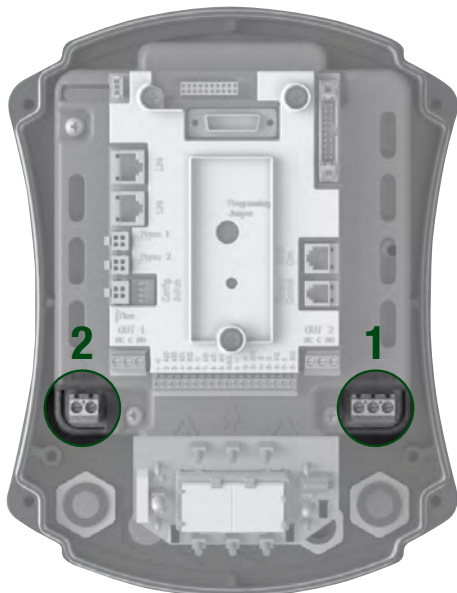

- 1 Connect the power supply to the pump
- 2 Connect eletrically the inverter

### MCE/P 30 – MCE/P 55

Installation

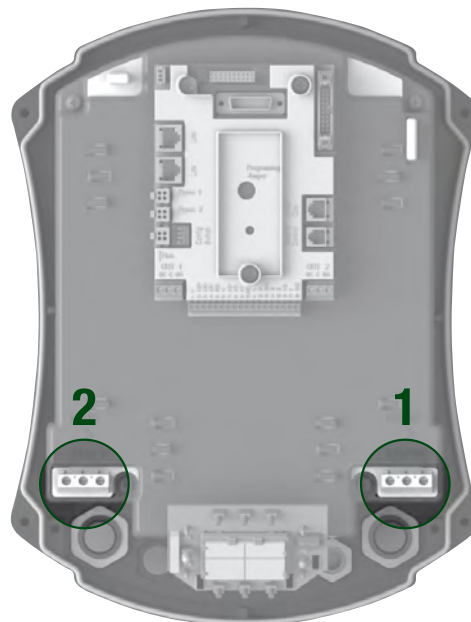

- 1 Connect the power supply to the pump
- 2 Connect eletrically the inverter

### MCE/P 110 – MCE/P 150

Installation

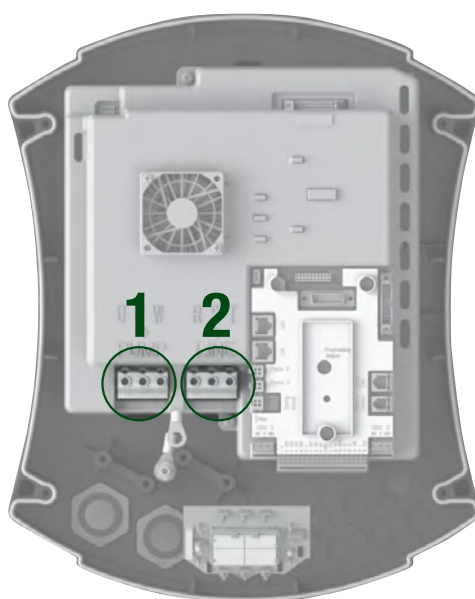

- 1 Connect the power supply to the pump
- 2 Connect eletrically the inverter

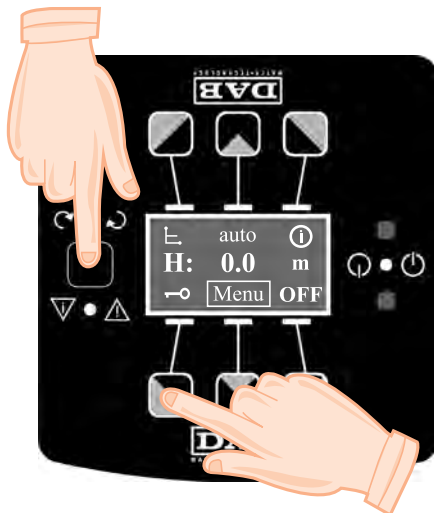
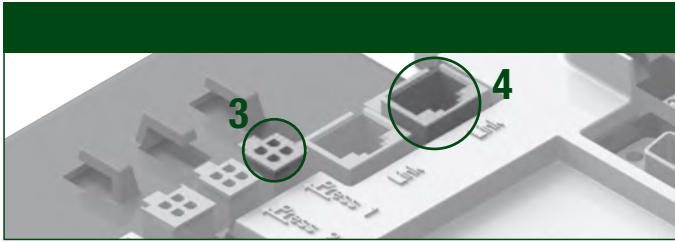

**3. Sensor lead connection**

The pressure sensor lead must be connected to press1

**4. Communication lead connection**

In a twin system, connect the communication lead between the two inverters

**5. MCE/C Configuration**

Close the cover and power up the inverter, the display will show

**6. Inverter unlocking**

Press and hold the key button and side button for 5 seconds until the key symbol disappears (See Fig. 6)



**Button functions**

The central button enables the user to scroll through the parameters Buttons + and – are used to input the required value. The value is saved if the OK button is pressed for 3 seconds

**7. Installation Menu**

Press and hold the central button for 5 seconds until the product name is displayed.

**8. Installation Menu**

Briefly press the central button to display the rated frequency of the pump, **Fn**, and modify if necessary

**9. Current control protection settings**

**In:** Rated current of pump.

Set the pump protection current according to the data of the electric pump

**10. Setting the direction of rotation**

Press + and - to set **Rt** (direction of pump rotation).

**11. Optional parameters**

if necessary, set: Minimum frequency, maximum frequency, **Rpm**

**12. Setting the type of pressure sensor**

Select the type of differential pressure sensor installed

**13. Set the maximum pump pressure head**

**14. Setting the carrier frequency**

If necessary, set the carrier frequency value.



If necessary, return to the installation menu from the home page and press and hold the central button for 5 seconds.



# INPUT AND OUTPUT ELECTRICAL CONNECTIONS

The MCE/C has 2 digital inputs, one analogue input and 2 digital outputs, allowing a number of interface solutions to be created with more complex installations.

## Digital Inputs

The screen-printed key to the digital inputs is provided on the base of the 18 pin terminal board:

- 11 - V+
- 15 - I2
- 16 - I1/I2
- 17 - I1
- 18 - GND

The inputs can be excited in both direct and alternating current. The electrical characteristics of the inputs are illustrated below.

ELECTRICAL CHARACTERISTICS OF INPUTS		
	DC Inputs [V]	AC Inputs [Vrms]
Minimum excitation voltage [V]	8	6
Maximum shut-off voltage [V]	2	1,5
Maximum permissible voltage [V]	36	36
Current absorption at 12V [mA]	3,3	3,3
Max. permitted cable cross-section [mm <sup>2</sup> ]	2,13	
N.B. The inputs can be controlled with any polarity (positive or negative in relation to their own ground)		

R1	R2	SYSTEM STATUS
Open	Open	Pump stopped OFF
Open	Close	Pump stopped OFF
Close	Open	Pump running with set-point set by user - AU
Close	Close	Pump running with reduced set-point - ECONOMY

## Outputs:

The output connections illustrated below refer to the two 3-pin terminal boards marked OUT1 and OUT2, also marked with the terminal contact type (NC = Normally Closed, C = Common, NO = Normally Open).

OUTPUT CONTACT CHARACTERISTICS	
Contact type	NO, NC
Max. rated voltage [V]	250
Max. rated current [A]	5 If resistive load / 2,5 If inductive load
Max. permitted cable cross-section [mm <sup>2</sup> ]	3,80

FUNCTIONS ASSOCIATED TO THE OUTPUTS	
OUT1	Alarms / No Alarms in system
OUT2	Pump running / Pump stopped

## Analogue Input for Constant Curve Control Mode with Remote Analogue Signal

The screen-printed marking of the 0-10V analogue input is provided on the base of the 18 pin terminal board:

- A1V (pin 9): Positive pole
- GND (pin 10): Negative pole

The function associated to the 0-10V analogue input is regulation of the pump rpm in proportion to the voltage on the 0-10V input itself.

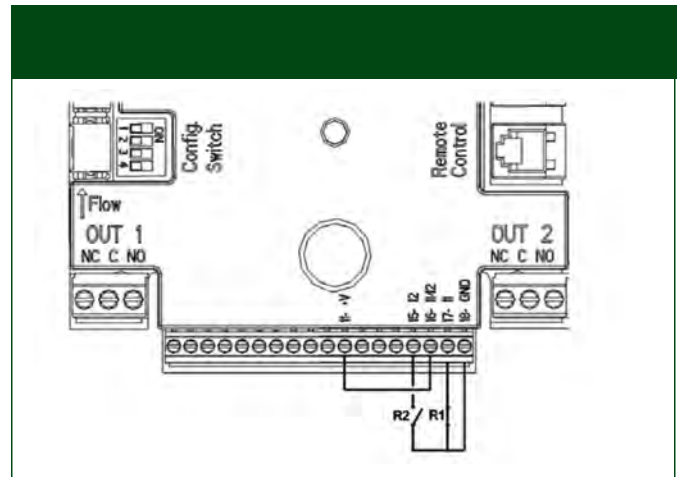

If a voltage is available and not a contact, it can still be used to control the inputs: do not use the +V and GND terminals and connect the voltage source to the input required complying with the characteristics detailed above.

FUNCTIONS ASSOCIATED TO THE DIGITAL INPUTS	
L1	Start/Stop: If input 1 is activated from the control panel, pump start and stop can be remote controlled.
L2	Economy: If input 2 is activated from the control panel, the set-point reduction function can be remote controlled.

In the example shown, light L1 comes on when there is an alarm in the system and goes out when no malfunctions of any kind are detected, while light L2 comes on when the pump is running and goes out when it is stopped.

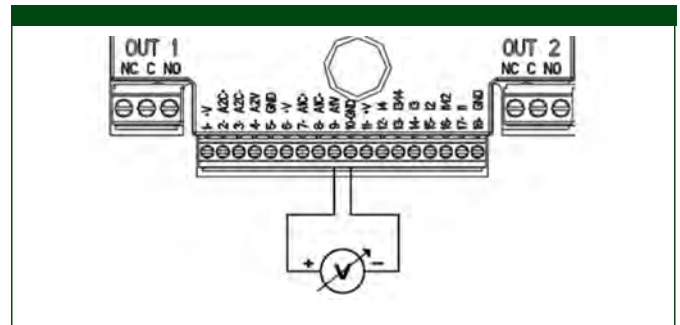
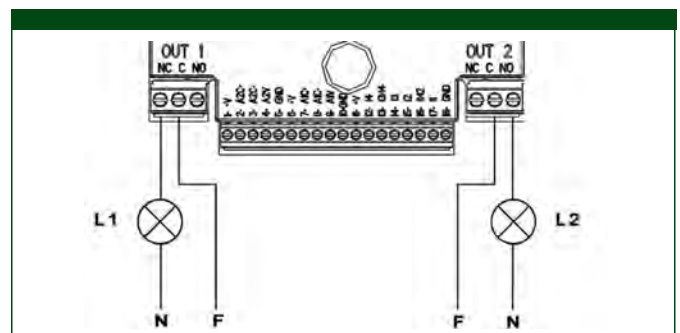





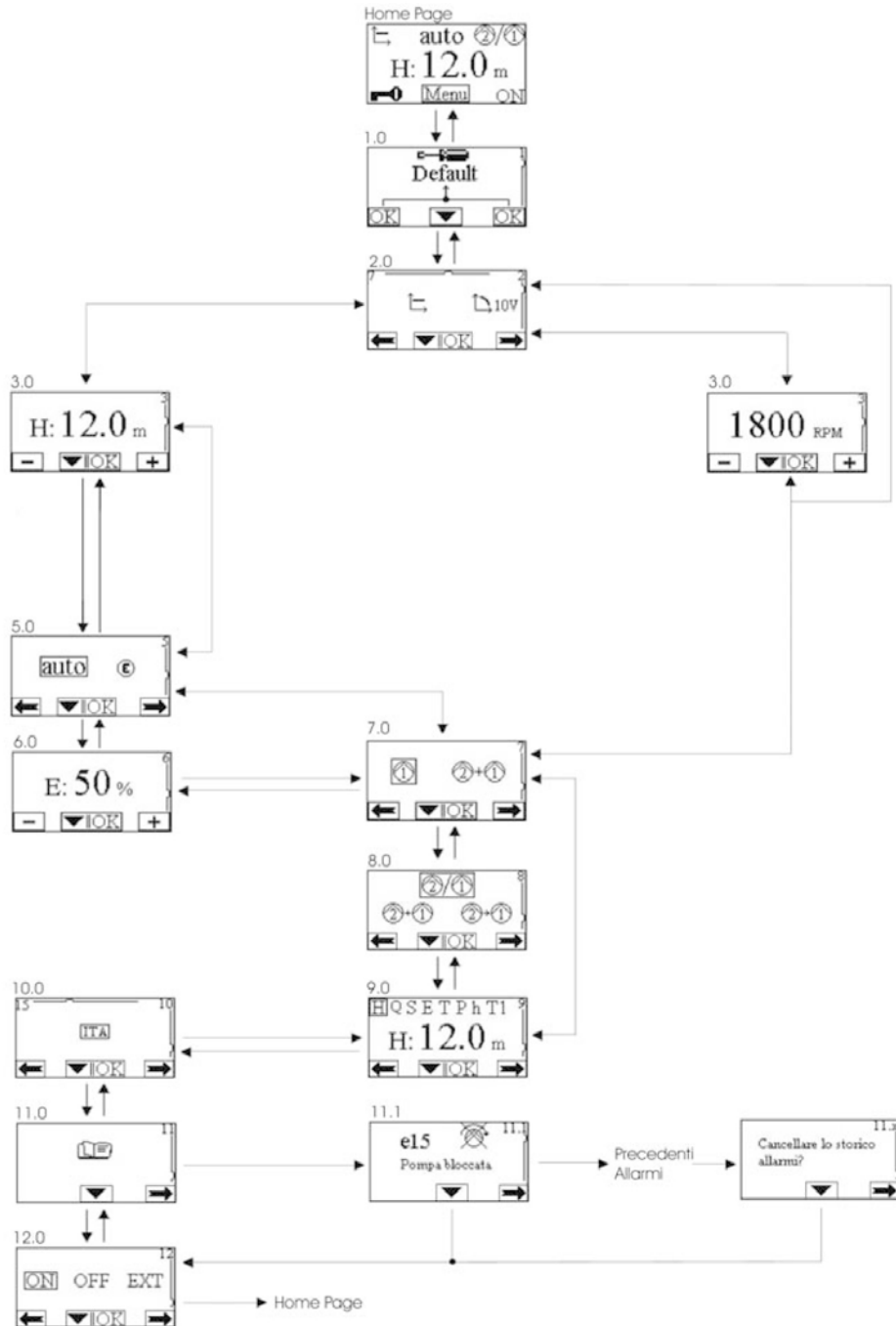





## MCE/C MENU CONFIGURATION

The settings are made by passing from page to page in the circulator setup menu.

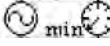

## DESCRIPTION OF PARAMETERS WHICH CAN BE DISPLAYED

Symbol	Description
HSEPh	Display of parameters
H	Head in m
S	Speed (rpm)
E	0-10 V analogue input
P	Power in kW
h	Operating hours

Alarm code	Alarm symbol	Alarm description
e0 - e16; e21		<b>Internal Error</b>
e17 - e19		<b>Short circuit</b>
e20		<b>Voltage Error</b>
e22 - e30		<b>Voltage Error</b>
e31		<b>Protocol Error</b>
e32 - e35		<b>Overheating</b>
e37		<b>Low voltage</b>
e38		<b>High voltage</b>
e39 - e40		<b>Overcurrent</b>
e43; e44; e45; e54		<b>Pressure sensor</b>
e46		<b>Pump Disconnected</b>

## Errors and how to deal with them

Display indication	Description	Reset
<b>E0 - E16</b>	<b>Internal Error</b>	- Switch off power to MCE- Wait 5 minutes then restore power to the MCE. - If the error persists, replace the MCE.
<b>E37</b>	<b>Mains voltage too low (LP)</b>	Switch off power to MCE - Wait 5 minutes then restore power to the MCE. - Check that the mains system voltage is correct; if necessary, restore it to the device's rated level.
<b>E38</b>	<b>Mains voltage too high (HP)</b>	-- Switch off power to MCE - Wait 5 minutes then restore power to the MCE. - Check that the mains system voltage is correct; if necessary, restore it to the device's rated level.
<b>E32-E35</b>	<b>Overheating of key electronic parts</b>	- Switch off power to MCE - Wait 5 minutes then remove the MCE from the pump and clean the motor casing. - Clean the heat sink
<b>E43-E45; E54</b>	<b>No signal from sensor</b>	- Check the sensor connection - If the sensor has failed, replace it.
<b>E39-E40</b>	<b>Overload cutout tripped</b>	- Check that the circulation pump turns freely. - Check that the level of antifreeze does not exceed the maximum level of 30%
<b>E21-E30</b>	<b>Voltage Error</b>	- Switch off power to MCE. - Wait 5 minutes then restore power to the MCE. - Check that the mains system voltage is correct; if necessary, restore it to the device's rated level.
<b>E31</b>	<b>Twin connection failure</b>	- Inspect the twin connection cable for damage. - Check that both circulation pumps can be supplied with power.



Via Marco Polo, 14 - Mestrino (PD) Italy - Phone +39.049.5125000 - Fax +39.049.5125950  
Customer Service: Tel.: +39.049.5125350 - Fax +39.049.5125959 - email: [customer.service@dwtgroup.com](mailto:customer.service@dwtgroup.com)  
[www.dabpumps.com](http://www.dabpumps.com)

**DAB PUMPS LTD.**

Unit 4 and 5, Stortford Hall Industrial Park  
Dunmow Road, Bishops Stortford, Herts  
CM23 5GZ - UK  
[salesuk@dwtgroup.com](mailto:salesuk@dwtgroup.com)  
Tel. +44 1279 652 776  
Fax +44 1279 657 727

**DAB PUMPS B.V.**

Albert Einsteinweg, 4  
5151 DL Drunen - Nederland  
[info.netherlands@dwtgroup.com](mailto:info.netherlands@dwtgroup.com)  
Tel. +31 416 387280  
Fax +31 416 387299

**DAB PUMPS B.V.**

Brusselstraat 150  
B-1702 Groot-Bijgaarden - Belgium  
[info.belgium@dwtgroup.com](mailto:info.belgium@dwtgroup.com)  
Tel. +32 2 4668353  
Fax +32 2 4669218

**DAB PUMPEN DEUTSCHLAND GmbH**

Tackweg 11  
D - 47918 Tönisvorst - Germany  
[info.germany@dwtgroup.com](mailto:info.germany@dwtgroup.com)  
Tel. +49 2151 82136-0  
Fax +49 2151 82136-36

**PUMPS AMERICA, INC. DAB PUMPS DIVISION**

3226 Benchmark Drive  
Ladson, SC 29456 USA  
[info.usa@dwtgroup.com](mailto:info.usa@dwtgroup.com)  
Tel. 1-843-824-6332  
Toll Free 1-866-896-4DAB (4322)  
Fax 1-843-797-3366

**DAB PUMPS IBERICA S.L.**

Parque Empresarial San Fernando  
Edificio Italia Planta 1ª  
28830 - San Fernando De Henares - Madrid  
Spain  
[info.spain@dwtgroup.com](mailto:info.spain@dwtgroup.com)  
Tel. +34 91 6569545  
Fax: +34 91 6569676

**OOO DWT GROUP**

100 bldg. 3 Dmitrovskoe highway  
127247 Moscow - Russia  
[info.russia@dwtgroup.com](mailto:info.russia@dwtgroup.com)  
Tel. +7 495 739 52 50  
Fax +7 495 485-3618

**DAB PUMPS CHINA**

No.40 Kaituo Road, Qingdao Economic & Technological  
Development Zone  
Qingdao City, Shandong Province, China  
PC: 266500  
[info.china@dwtgroup.com](mailto:info.china@dwtgroup.com)  
Fax +8653286812210  
Tel. +8653286812030-6270

**DWT South Africa**

Landmark Office Park (East Block) - 4th Floor  
17 Umgazi Road - Menlo Park - 0081 South Africa  
[info.sa@dwtgroup.com](mailto:info.sa@dwtgroup.com)  
Tel. +27 861 666 687  
Fax +27 346 1351